

# Wafer

WITH FLEXUNO



HIDDEN SPRING HINGES

# Wafer

WITH FLEXUNO

- Elegant design
- Nickel silver case / stainless steel mechanism
- For metal and plastic frames
- Integrated look in plastic temple
- Equipped with flexUno antirocking system
- Top of the case can be used as a design element for logos
- 75% of recycled nickel silver chips are used in the production of new cases

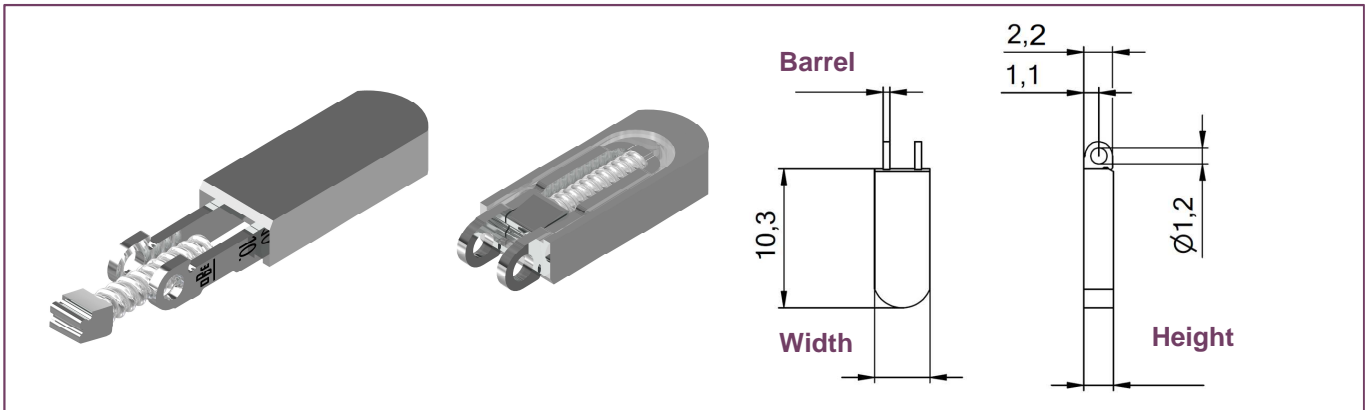

Width	Barrel	Height	Art.no.	Processing	Note
3.0 mm	0.4 mm	2.2 mm	60-04053 17-04053+44-44053+60-04053.050	for soldering	exchangeable
4.0 mm	0.5 mm	2.2 mm	60-04066 17-04066+44-44061+60-04061.050	for soldering	exchangeable
4.8 mm	0.5 mm	2.0 mm	60-04061	for welding	not exchangeable

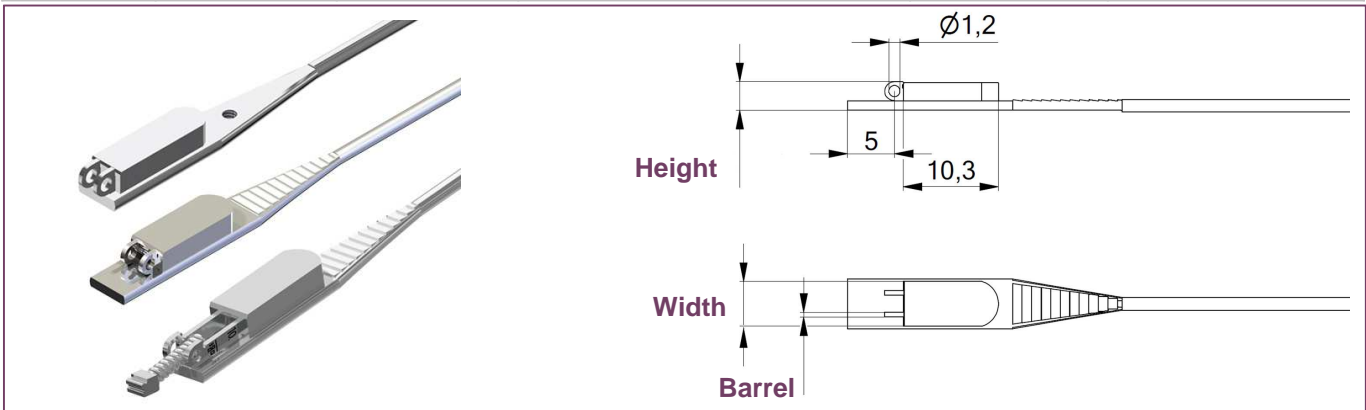













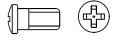

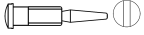

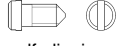

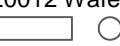

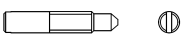
Width	Barrel	Height	Art.no.	Processing	Note
3.6 mm	0.4 mm	3.2 mm	73-04053.51X	soldered	exchangeable
		3.0 mm	73-04053.30X	welded	not exchangeable
4.0 mm	0.4 mm	3.0 mm	73-04053.40X	welded	not exchangeable for temple tip
4.5 mm	0.5 mm	3.2 mm	73-04066.70X	soldered	exchangeable
		3.0 mm	73-04066.30X	welded	not exchangeable
5.3 mm	0.5 mm	3.0 mm	73-04061.40X	welded	not exchangeable

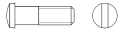
# Wafer

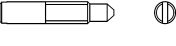
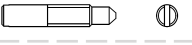
WITH FLEXUNO

## Matching parts

Front hinges	for Wafer 3.0	for Wafer 4.0	for Wafer 4.8	Hinge fixation	Fixation to front
Front hinges for plastic frames 90° 0°/ 6° inclination 	33-04153 33-04025 off center 33-04353 off center	33-04066 33-04266 off center	33-04061 33-04071 round foot 33-04261 off center	Screw	inserting
Front hinges for plastic frames 180° 	33-04253	33-04166	33-04161	99-02027 Wafer 3.0 99-02036 Wafer 4.0 99-02017 Wafer 4.8 	inserting
Step hinges 	52-04153 52-04154	52-04166	52-04161	99-01732 Wafer 4.0 	soldering
Rivet hinges 	-	51-05066	51-05061	99-02027.800 Wafer 3.0 99-02036.800 Wafer 4.0 99-02017.800 Wafer 4.8 	riveting with 11-20247  11-20251 11-20245 11-20246
Front hinges for soldering 	52-04053	52-04276	52-04261	self aligning for break off 99-02032 Wafer 3.0 	soldering
Front hinges for welding 	52-04253	-	52-04061	self aligning 	welding
Three barrel block hinges 	32-04062	-	32-04054	Pin 11-20012 Wafer 3.0 	screwing with 99-00065 Wafer 3.0 99-00064 Wafer 4.8 
One barrel block hinges 	32-04061	-	32-04053	Screw 99-02023 Wafer 4.8 	screwing with 99-01753 
<b>Only Wafer for welding</b> 	32-04055	32-04060	32-04060	Screw 99-00065 Wafer 3.0 	screwing with 99-00065 Wafer 3.0 99-00064 Wafer 4.0 & 4.8 
One barrel block hinges 	32-04056	32-04059	32-04059	Pin 11-20010 Wafer 4.0 & 4.8 	screwing with 99-01753 

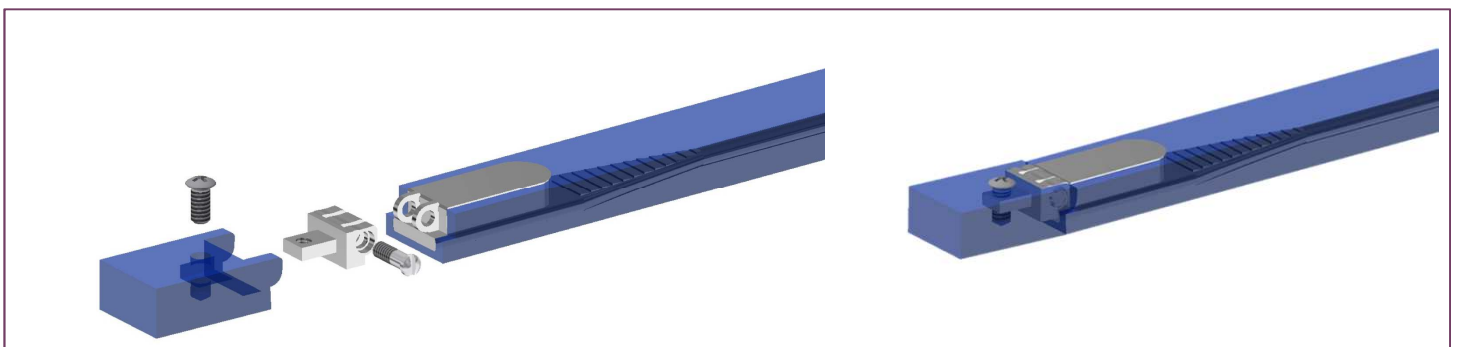



**OBE GmbH & Co. KG · Turnstr. 22 · 75228 Ispringen · Germany**  
**Tel. +49 7231 802-0 · [www.obe.de](http://www.obe.de) · [info@obe.de](mailto:info@obe.de)**